

## Square LED edge-lit recessed downlighters

The R4 is a UK designed and manufactured LED edge-lit down light built to a high specification. It uses fire retardant panels in both opal and low glare versions. Available in 3000 K and 4000 K, the two power choices are complemented with emergency derivatives and SmartScan energy saving versions.

Applications: Student accommodation, healthcare and general purpose use.

- Edge-lit diffuser technology eliminates visible LEDs
- Supplied with remote gear unit fitted with 2 m supply lead
- SmartScan versions fitted with TEE connector for LCM wiring
- SmartScan wireless technology removes the need for control cabling. Ideal for retro-fit

Notes: Low glare and SmartScan versions are IP40 below ceiling

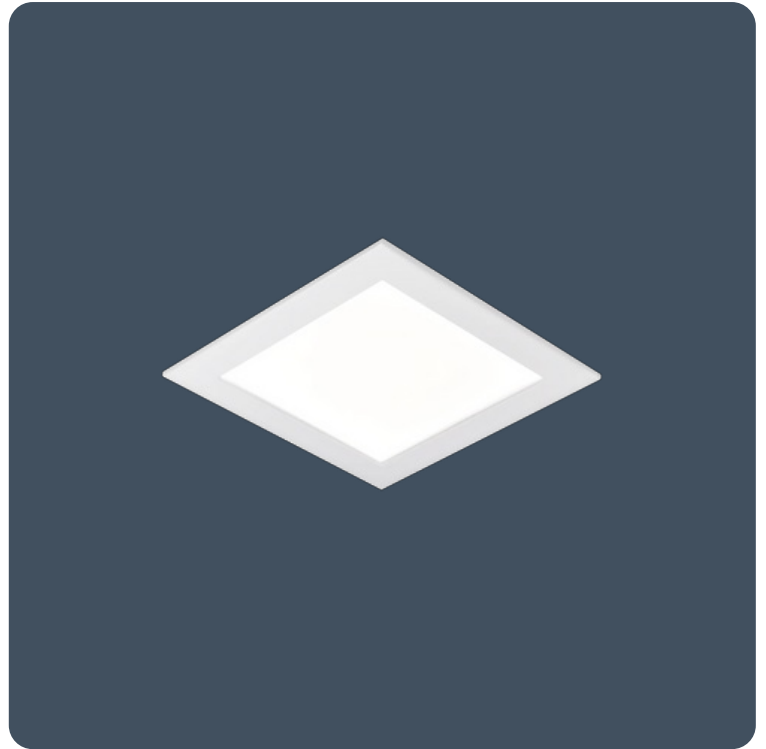

Up to IP54 (IP40 above ceiling)
Up to 121.5 LL/CW
SMARTSCAN
LUXGUARD

### Specification

|                               |          |           |                                 |
|-------------------------------|----------|-----------|---------------------------------|
| Mounting                      | Recessed | IP rating | Up to IP54 (IP40 above ceiling) |
| Max presence detection height | 8 m      |           |                                 |

### Lighting

|          |                                     |              |                     |
|----------|-------------------------------------|--------------|---------------------|
| Optic    | Low glare diffuser<br>Opal diffuser | Lumen output | 1,055 lm - 2,450 lm |
| Efficacy | Up to 121.5 LL/CW                   |              |                     |

### Emergency data

|                        |                 |                       |                             |
|------------------------|-----------------|-----------------------|-----------------------------|
| Emergency lumen output | 185 lm - 215 lm | Emergency type        | Maintained                  |
| Emergency duration     | 3 hours         | Battery specification | Nickel Metal Hydride (NiMH) |

### Power

|           |            |               |             |
|-----------|------------|---------------|-------------|
| LED power | 9 W - 18 W | Circuit power | 10 W - 22 W |
|-----------|------------|---------------|-------------|

## LED characteristics

|                    |                |                    |                  |
|--------------------|----------------|--------------------|------------------|
| CRI                | 80+            | Colour temperature | 3000 K<br>4000 K |
| Rated life (hours) | 95 K - L80/B10 |                    |                  |

## Compliance

|              |     |                      |       |
|--------------|-----|----------------------|-------|
| UKCA         | Yes | CE                   | Yes   |
| C-Tick (Aus) | Yes | Thermoplastic rating | TP(a) |

## Dimensions

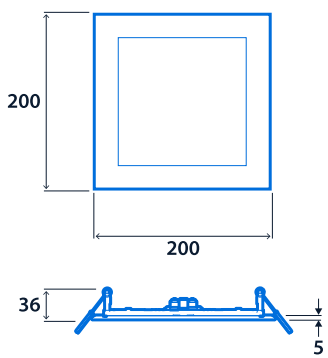

Cut-out - 180 x 180mm  
 Minimum void depth:  
 Standard - 40mm  
 Smart & Emergency - 90mm

### Standard Remote Driver

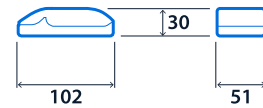

### LED Downlighter Power Unit

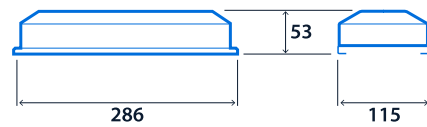

Luminaire connected to gear by 450mm lead

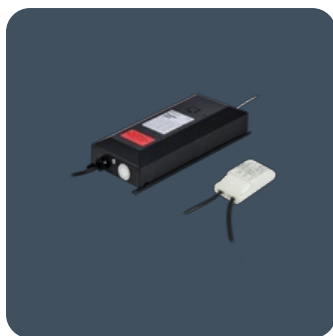
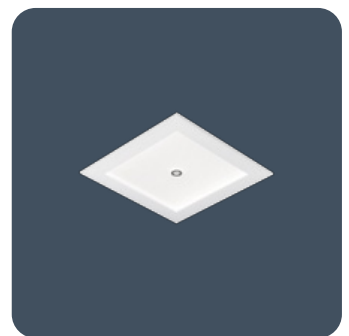
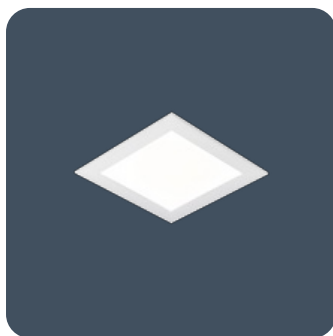



**Click or scan here**  
View R4 variants using our  
online filtering tool



Information is correct as of 12 Mar 2025, however must not be interpreted as a guarantee of individual product performance and/or characteristics. We reserve the right to alter specifications and designs without prior notice.